









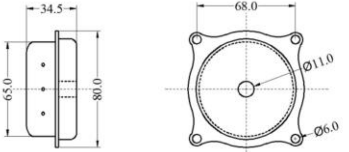

SERIAL NUMBER	DRAWING SIZE	PICTURE	PICTURE	DRAWING NUMBER
1	尺寸: $\phi 60 \times H35mm$ 重量: 299g Dimensions: $\phi 60 \times H35mm$ Weight: 299g 			ZW-DZY 双
2	尺寸: $\phi 65 \times H34.5mm$ 重量: 343g Dimensions: $\phi 65 \times H34.5mm$ Weight: 343g 			ZW-带金注塑
3	尺寸: $\phi 66 \times H34.5mm$ 重量: 309g Dimensions: $\phi 66 \times H34.5mm$ Weight: 309g 			ZW-新 4 寸注塑
4	尺寸: $\phi 69 \times H35.5mm$ 重量: 344g Dimensions: $\phi 69 \times H35.5mm$ Weight: 344g 			ZW-4 寸 DH 双
5	尺寸: $\phi 64 \times H36mm$ 重量: 298g Dimensions: $\phi 64 \times H36mm$ Weight: 298g 			ZW-DZSJ

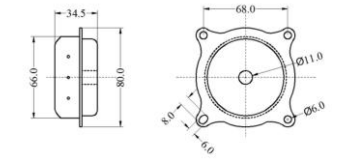
23	<p>尺寸: $\phi 55 \times H38\text{mm}$ 重量: 303g Dimensions: $\phi 55 \times H38\text{mm}$ Weight: 303g</p> 			ZW-9 大
----	----------------------------------------------------------------------------------------------------------------------------------------------------------------------------------------------------------------------	----------------------------------------------------------------------------------	-----------------------------------------------------------------------------------	--------





24	<p>尺寸: $\phi 60 \times H35.5\text{mm}$ 重量: 302g Dimensions: $\phi 60 \times H35.5\text{mm}$ weight: 302g</p> 			ZW-小花边
----	---------------------------------------------------------------------------------------------------------------------------------------------------------------------------------------------------------------------------	-----------------------------------------------------------------------------------	------------------------------------------------------------------------------------	--------

25	<p>尺寸: $\phi 59 \times H37\text{mm}$ 重量: 341g Dimensions: $\phi 59 \times H37\text{mm}$ Weight: 341g</p> 			ZW-大花丝
----	-----------------------------------------------------------------------------------------------------------------------------------------------------------------------------------------------------------------------	-----------------------------------------------------------------------------------	------------------------------------------------------------------------------------	--------



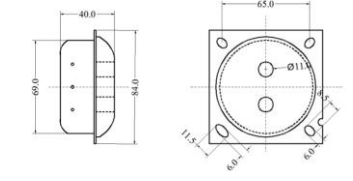

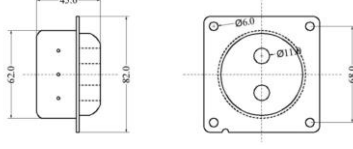





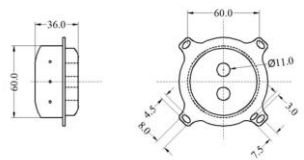

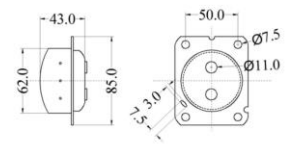
26	<p>尺寸: $\phi 68 \times H35.5\text{mm}$ 重量: 334g Dimensions: $\phi 68 \times H35.5\text{mm}$ Weight: 334g</p> 			ZW-圆双
----	----------------------------------------------------------------------------------------------------------------------------------------------------------------------------------------------------------------------------	------------------------------------------------------------------------------------	-------------------------------------------------------------------------------------	-------

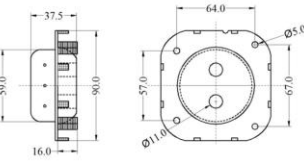

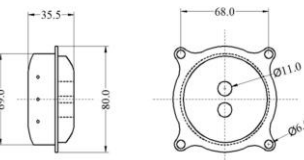

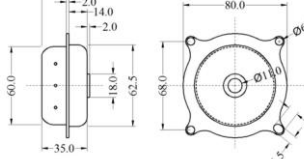

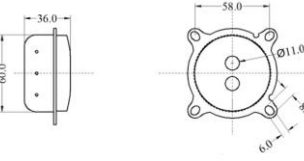



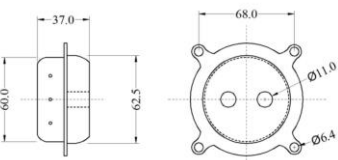

27	<p>尺寸: $\phi 62 \times H36\text{mm}$ 重量: 302g Dimensions: $\phi 62 \times H36\text{mm}$ Weight: 302g</p> 			ZW-ZB3 寸
----	-------------------------------------------------------------------------------------------------------------------------------------------------------------------------------------------------------------------------	-------------------------------------------------------------------------------------	--------------------------------------------------------------------------------------	----------

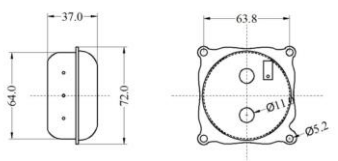
33				ZW-5 寸双副
34	<p>尺寸: $\phi 55 \times H38\text{mm}$ 重量: 312g Dimensions: $\phi 55 \times H38\text{mm}$ Weight: 312g</p> 			ZW-螺丝加长丝
35	<p>尺寸: $\phi 60 \times H36\text{mm}$ 重量: 299g Dimensions: $\phi 60 \times H36\text{mm}$ Weight: 299g</p> 			ZW-3 寸 DH

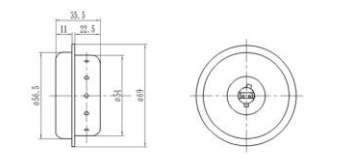
36	<p>尺寸: $\phi 69 \times H40\text{mm}$ 重量: 390g Dimensions: $\phi 69 \times H40\text{mm}$ Weight: 390g</p> 			ZW-4 寸双副
37	<p>尺寸: $\phi 62 \times H45\text{mm}$ 重量: 384g Dimensions: $\phi 62 \times H45\text{mm}$ Weight: 384g</p> 			ZW-MD 双副

38	<p>尺寸: $\phi 62 \times H36\text{mm}$ 重量: 333g Dimensions: $\phi 62 \times H36\text{mm}$ Weight: 333g</p> 			ZW-6 双
39	<p>尺寸: $\phi 55 \times H38\text{mm}$ 重量: 304g Dimensions: $\phi 55 \times H38\text{mm}$ Weight: 304g</p> 			ZW-螺丝不带丝
40	<p>尺寸: $\phi 62 \times H36\text{mm}$ 重量: 333g Dimensions: $\phi 62 \times H36\text{mm}$ Weight: 333g</p> 			ZW-6
41	<p>尺寸: $\phi 54 \times H46\text{mm}$ 重量: 322g Dimensions: $\phi 54 \times H46\text{mm}$ Weight: 322g</p> 			ZW-螺丝副
42	<p>尺寸: $\phi 54.5 \times H38\text{mm}$ 重量: 290g Dimensions: $\phi 54.5 \times H38\text{mm}$ Weight: 290g</p> 			ZW-螺丝双带丝

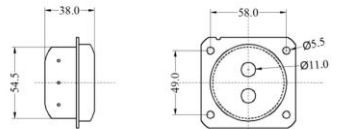
48	<p>尺寸: $\phi 60 \times H36\text{mm}$ 重量: 308g Dimensions: $\phi 60 \times H36\text{mm}$ Weight: 308g</p> 			ZW-DZSJ 双
49	<p>尺寸: $\phi 62 \times H43\text{mm}$ 重量: 376g Dimensions: $\phi 62 \times H43\text{mm}$ Weight: 376g</p> 			ZW-5 双
50	<p>尺寸: $\phi 59 \times H37.5\text{mm}$ 重量: 377g Dimensions: $\phi 59 \times H37.5\text{mm}$ Weight: 377g</p> 			ZW-JY
51	<p>尺寸: $\phi 69 \times H35.5\text{mm}$ 重量: 325g Dimensions: $\phi 69 \times H35.5\text{mm}$ Weight: 325g</p> 			ZW-4 寸双铝头
52	<p>尺寸: $\phi 60 \times H35\text{mm}$ 重量: 313g Dimensions: $\phi 60 \times H35\text{mm}$ Weight: 313g</p> 			ZW-小四角
53	<p>尺寸: $\phi 60 \times H36\text{mm}$ 重量: 304g Dimensions: $\phi 60 \times H36\text{mm}$ Weight: 304g</p> 			ZW-3 寸 DH 双



54	<p>尺寸: $\phi 60 \times H37\text{mm}$ 重量: 331g Dimensions: $\phi 60 \times H37\text{mm}$ Weight: 331g</p> 			ZW-4 寸双
55	<p>尺寸: $\phi 60 \times H38\text{mm}$ 重量: 306g Dimensions: $\phi 60 \times H38\text{mm}$ weight: 306g</p> 			ZW-小花双不带打铁
56	<p>尺寸: $\phi 64 \times H37$ 重量: 323g Dimensions: $\phi 64 \times H37$ Weight: 323g</p> 			ZW-小花双
57	<p>尺寸: $\phi 54 \times H35.5\text{mm}$ 重量: 287g Dimensions: $\phi 54 \times H35.5\text{mm}$ weight: 287g</p> 			ZW-LSY 单
58	<p>尺寸: $\phi 59 \times H38\text{mm}$ 重量: 308g Dimensions: $\phi 59 \times H38\text{mm}$ Weight: 308g</p> 			ZW-蝴蝶边
59	<p>尺寸: $\phi 54.5 \times H38\text{mm}$ 重量: 290g Dimensions: $\phi 54.5 \times H38\text{mm}$ Weight: 290g</p> 			ZW-螺丝

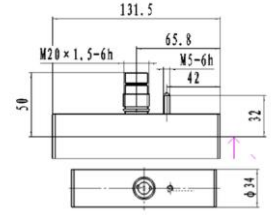
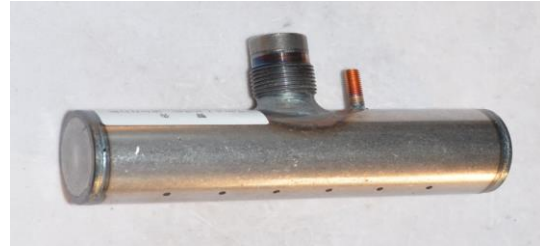





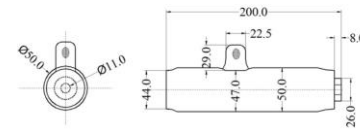

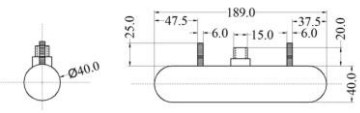

65	<p>尺寸: $\phi 45 \times H190\text{mm}$ 重量: 1023g Dimensions: $\phi 45 \times H190\text{mm}$ Weight: 1023g</p> 			ZW-45 管双
----	--------------------------------------------------------------------------------------------------------------------------------------------------------------------------------------------------------------------------	--------------------------------------------------------------------------------	----------------------------------------------------------------------------------	----------

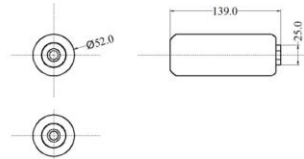

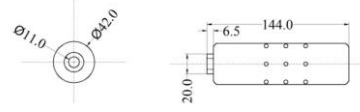

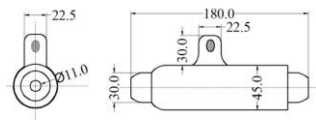

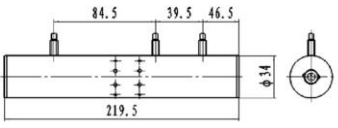
66	<p>尺寸: $\phi 34 \times H131.5\text{mm}$ 重量: 398g Dimensions: $\phi 34 \times H131.5\text{mm}$ Weight: 398g</p> 			ZW-FKS
----	-----------------------------------------------------------------------------------------------------------------------------------------------------------------------------------------------------------------------------	------------------------------------------------------------------------------------	--	--------



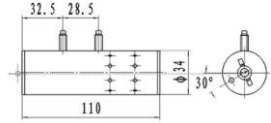

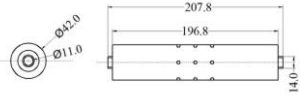
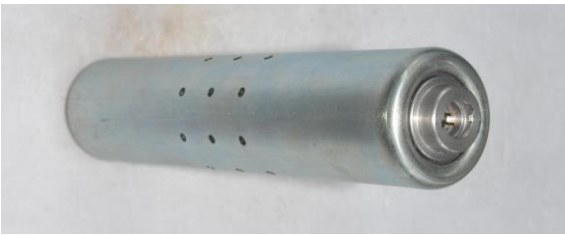
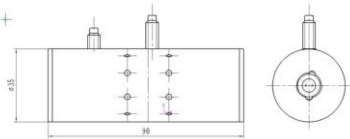

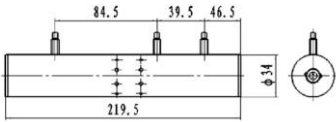

67	<p>尺寸: $\phi 45 \times H208.5\text{mm}$ 重量: 1177g Dimensions: $\phi 45 \times H208.5\text{mm}$ Weight: 1177g</p> 			ZW-MT 单
----	-------------------------------------------------------------------------------------------------------------------------------------------------------------------------------------------------------------------------------	-----------------------------------------------------------------------------------	------------------------------------------------------------------------------------	---------

68	<p>尺寸: $\phi 45 \times H208.5\text{mm}$ 重量: 1196g Dimensions: $\phi 45 \times H208.5\text{mm}$ Weight: 1196g</p> 			ZW-MT 不带丝
----	--------------------------------------------------------------------------------------------------------------------------------------------------------------------------------------------------------------------------------	------------------------------------------------------------------------------------	-------------------------------------------------------------------------------------	-----------



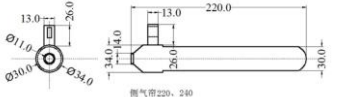
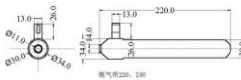

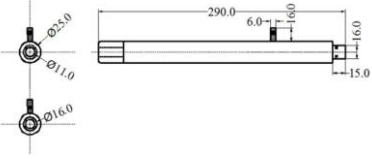
69	<p>尺寸: $\phi 50 \times H200\text{mm}$ 重量: 1066g Dimensions: $\phi 50 \times H200\text{mm}$ Weight: 1066g</p> 			ZW-KD
----	-----------------------------------------------------------------------------------------------------------------------------------------------------------------------------------------------------------------------------	--------------------------------------------------------------------------------------	--	-------

70	<p>尺寸: $\phi 40 \times H189\text{mm}$ 重量: 1017g Dimensions: $\phi 40 \times H189\text{mm}$ Weight: 1017g</p> 			ZW-BM
71	<p>尺寸: $\phi 52 \times H139\text{mm}$ 重量: 897g Dimensions: $\phi 52 \times H139\text{mm}$ Weight: 897g</p> 			ZW-52 管
72	<p>尺寸: $\phi 42 \times H144\text{mm}$ 重量: 793g Dimensions: $\phi 42 \times H144\text{mm}$ Weight: 793g</p> 			ZW-42 管单
73	<p>尺寸: $\phi 45 \times H180\text{mm}$ 重量: 838g Dimensions: $\phi 45 \times H180\text{mm}$ Weight: 838g</p> 			ZW-途双
74	<p>尺寸: $\phi 34 \times H219.5\text{mm}$ 重量: 794g Dimensions: $\phi 34 \times H219.5\text{mm}$ Weight: 794g</p> 			ZW-307 副

80	<p>尺寸: $\phi 34 \times H110\text{mm}$ 重量: 363g Dimensions: $\phi 34 \times H110\text{mm}$ Weight: 363g</p> 			ZW-110 长
81	<p>尺寸: $\phi 42 \times H207.8\text{mm}$ 重量: 1046g Dimensions: $\phi 42 \times H207.8\text{mm}$ Weight: 1046g</p> 		ZW-42 管双	
82	<p>尺寸: $\phi 35 \times H90\text{mm}$ 重量: 290g Dimensions: $\phi 35 \times H90\text{mm}$ Weight: 290g</p> 		ZW-307 主	
83	<p>尺寸: $\phi 34 \times H219.5\text{mm}$ 重量: 794g Dimensions: $\phi 34 \times H219.5\text{mm}$ Weight: 794g</p> 		ZW-307 双副	

84			ZW-ADQL210	
85			ZW-原厂 290 长	
86	<p>尺寸: $\phi 30 \times H220\text{mm}$ 重量: 669g Dimensions: $\phi 30 \times H220\text{mm}$ Weight: 669g</p> 	<p>尺寸: $\phi 30 \times H240\text{mm}$ 重量: 694g Dimensions: $\phi 30 \times H240\text{mm}$ Weight: 694g</p> 		ZW-CQL 长
87	<p>尺寸: $\phi 25 \times H290\text{mm}$ 重量: 497g Dimensions: $\phi 25 \times H290\text{mm}$ Weight: 497g</p> 		ZW-290 长	

88	<p>尺寸: $\phi 25 \times H270\text{mm}$ 重量: 468g Dimensions: $\phi 25 \times H270\text{mm}$ Weight: 468g</p> 		ZW-270 长
89			ZW-240 长
90			ZW-200 长
91	<p>尺寸: $\phi 30 \times H270\text{mm}$ 重量: 546g Dimensions: $\phi 30 \times H270\text{mm}$ Weight: 546g</p> 		ZW-XCQL





101	100	99	98
<p>尺寸: $\phi 30 \times H280\text{mm}$ 重量: 420g Dimensions: $\phi 30 \times H280\text{mm}$ Weight: 420g</p>  <p>奥迪气帘210、230、250、280、300、350</p>			
			
ZW-ADQL230	ZW-ADQL280	ZW-ADQL300	ZW-ADQL350



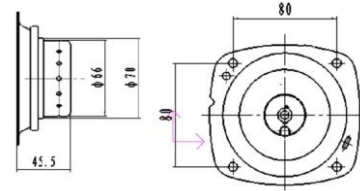

102			ZW-ADQL210
-----	--	-----------------------------------------------------------------------------------	------------

103				ZW-圆双小圆框
-----	-----------------------------------------------------------------------------------	-----------------------------------------------------------------------------------	--	----------

104				ZW-7 三角花框
-----	-----------------------------------------------------------------------------------	-----------------------------------------------------------------------------------	--	-----------







105	<p>尺寸: $\phi 70 \times H45.5\text{mm}$ 重量: 424g Dimensions: $\phi 70 \times H45.5\text{mm}$ weight: 424g</p> 			ZW-7 小框
-----	-----------------------------------------------------------------------------------------------------------------------------------------------------------------------------------------------------------------------------	------------------------------------------------------------------------------------	-------------------------------------------------------------------------------------	---------



106				ZW-圆双大框
107	<p>尺寸: $\varnothing 70 \times H45.5\text{mm}$ 重量: 440g Dimensions: $\varnothing 70 \times H45.5\text{mm}$ weight: 440g</p> 			ZW-7 大框







108		<p>толщина 58</p> 		ZW-001
109				ZW-002
110				ZW-003
111				ZW-004
112				ZW-005

113			ZW-006
114			ZW-007
115			ZW-008
116			ZW-009
117			ZW-010

118			ZW-011
119			ZW-012
120			ZW-013
121			ZW-014

122			ZW-015
123			ZW-016
124			ZW-017
125			ZW-018
126			ZW-019
127			ZW-020

128			ZW-021
129			ZW-022
130			ZW-023

131			ZW-024
132			ZW-025
133			ZW-026
134			ZW-027
135			ZW-028
136			ZW-029
137			ZW-030

138			ZW-031
139			ZW-032
140			ZW-033



SERIAL NUMBER	Name	Basic Type	Fire Direction	DRAWING NUMBER	Technical Parameters	Actual Picture	Size (mm)
1				GS-H-01	电 阻: $2.0 \pm 0.2 \Omega$		H:23.3 ± 0.2
					峰值时间: $\leq 3ms$		
					峰值压力: 5-7Mpa (5CC)		
					发火电流: 1.2A/2ms		
2				GS-H-02	电 阻: $2.0 \pm 0.2 \Omega$		H:22.0 ± 0.1
					峰值时间: $\leq 3ms$		
					峰值压力: 1-2Mpa (5CC)		
					发火电流: 1.2A/2ms		
3	Elect ric Start er	Igni tion	Vert ical fire	GS-08	电 阻: $2.0 \pm 0.2 \Omega$		H:22.0 ± 0.1
					峰值时间: $\leq 3ms$		
					峰值压力: 1-1.5Mpa (5CC)		
					发火电流: 1.2A/2ms		
4				GS-H-04	电 阻: $2.0 \pm 0.2 \Omega$		H:22.8 ± 0.2
					峰值时间: $\leq 3ms$		
					峰值压力: 5-10Mpa (5CC)		
					发火电流: 1.2A/2ms		

5			GS-H-05	电 阻: 1-4 Ω		Can be custo mized
				峰值时间: $\leq 3\text{ms}$		
				峰值压力: 5-10Mpa (5CC)		
				发火电流: 1.2A/2ms		

Electric starter quotation

length

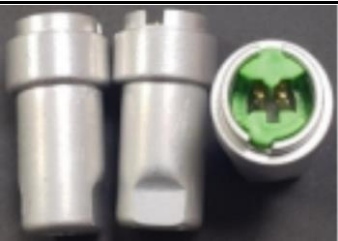
6				GS-H-7	电阻: $2.0 \pm 0.2 \Omega$		D: 20 ± 0.2
					峰值时间: $\leq 3\text{ms}$		
					峰值压力: 6-10Mpa (5CC)		
					发火电流: 1.2A/2ms		
7			Circular (three-hole) firing	GS-H-03	电阻: $2.0 \pm 0.2 \Omega$		H: 23.3 ± 0.2
					峰值时间: $\leq 3\text{ms}$		
					峰值压力: 5-10Mpa (5CC)		
					发火电流: 1.2A/2ms		
8			Circular (three-hole) firing	GS-H-06	电阻: $2.0 \pm 0.2 \Omega$		H: 22.8 ± 0.2
					峰值时间: $\leq 3\text{ms}$		
					峰值压力: 5-10Mpa (5CC)		
					发火电流: 1.2A/2ms		
9				GS-H-07	电阻: $1-4 \Omega$		Can be custo mized lengt
					峰值时间: $\leq 3\text{ms}$		
					峰值压力: 5-10Mpa (5CC)		
					发火电流: 1.2A/2ms		
10	The gas	Gas prod	-	GS-Q-01	电阻: $2.0 \pm 0.3 \Omega$		D: 31.5 ± 0.5
					峰值压力: 40-50Mpa (10CC)		
					发火电流: 1.2A/2ms		

11	generator	uction	-	GS-Q-02	电阻: $2.0 \pm 0.3 \Omega$		D:27.5 ± 0.5	12 - GS-Q- 03 11.5 1.6 D:31.5
					峰值压力: 20-30Mpa (10CC)			
					发火电流: 1.2A/2ms			
					电阻: $2.0 \pm 0.3 \Omega$		D:31.5	
					峰值压力: 20-30Mpa (10CC)			

					发火电流: 1.2A/2ms		±0.5
13				GS-Q-04	电 阻: 2.0±0.3		D: 50±0 .2
14				GS-Q-05	电 阻: 2.0±0.3 Ω		
15				GS-Q-06	电 阻: 2.0±0.3 Ω		
16	Speci al power sourc e devic e	work clas s	-	GS-T-01	电 阻: 2.0±0.3 Ω		D:31.5 ±0.5
					峰值压力: 20-30Mpa (10CC)		
					发火电流: 1.2A/2ms		
					电 阻: 2.0±0.3 Ω		Custo mized

12 -
GS-Q-03
11.5 1.6

17			-	GS-T-02	发火电流: 1.2A/2ms		products	13	1.8
18			-	GS-T-03	电 阻: 2.0±0.3 Ω			15	2.2
					发火电流: 1.2A/2ms				
19				GS-T-04				15	2.2
20				GS-T-05				15	2.2
21				GS-T-06				15	2.2

17

-

GS-T-02

13

1.8

22				GS-T-07				18	2.5
23				GS-T-08				22	3.2
24				GS-T-09				23	3.2
25				GS-T-10				20	2.8



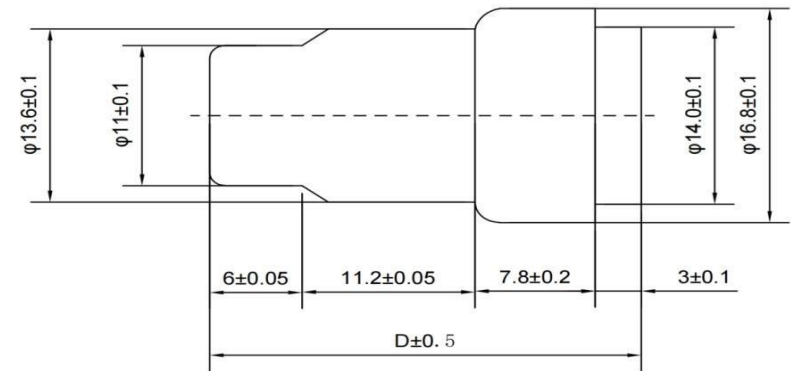
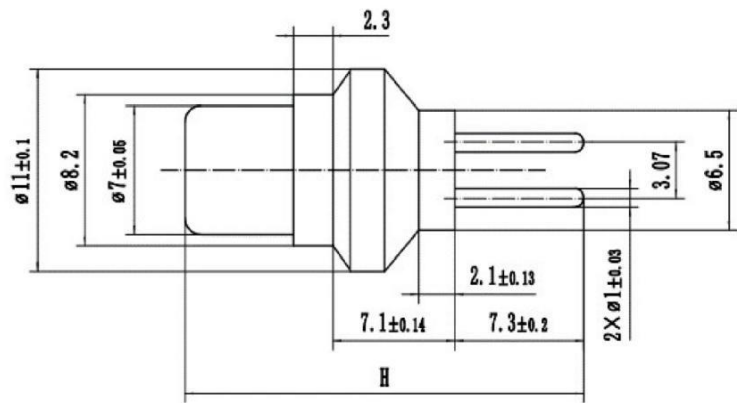





Attachment: Product Dimensions Drawing:





Electric starter product outline

Outline drawing of micro gas

Seat belt inflator quotation

ARTICLE NO.	PICTURE	MODEL
1		A Set
2		A Set
3		A Set/one side
4		A Set/one side
5		A Set/one side
6		A Set
7		A Set
8		A Set
9		A Set

10		A Set
11		A Set
12		A Set
13		A Set
14		A Set
15		A Set
16		One
17		One
18		One
19		A Set

20		A Set
----	-----------------------------------------------------------------------------------	-------

21		A Set
----	-----------------------------------------------------------------------------------	-------

22		One
----	-----------------------------------------------------------------------------------	-----

23		A Set
----	-----------------------------------------------------------------------------------	-------

24		A Set
----	------------------------------------------------------------------------------------	-------

25		A Set
----	-------------------------------------------------------------------------------------	-------

26		A Set
----	-------------------------------------------------------------------------------------	-------

27		A Set
----	-------------------------------------------------------------------------------------	-------

28		A Set
----	-------------------------------------------------------------------------------------	-------

29



A Set